

CYL-1 Cylinder Regulators Outline & Mounting Dimensions

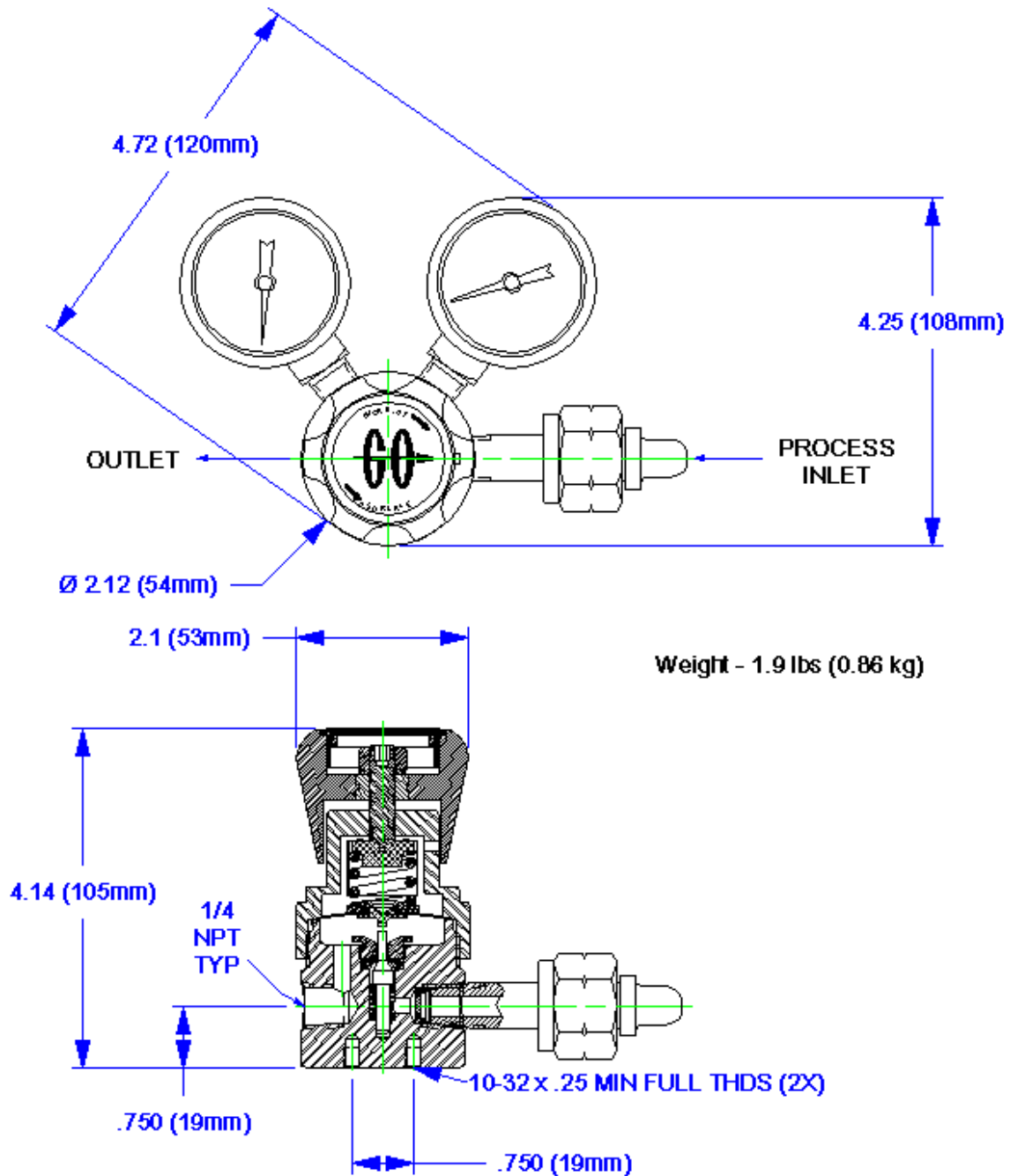

GO Regulator

405 Centura Court • PO Box 4866 • Spartanburg, SC 29303
Phone (864) 574-7966 • Fax (864) 574-5608
www.goreg.com • sales@goreg.com