

## PR-5 Series Pressure Regulator Outline & Mounting Dimensions

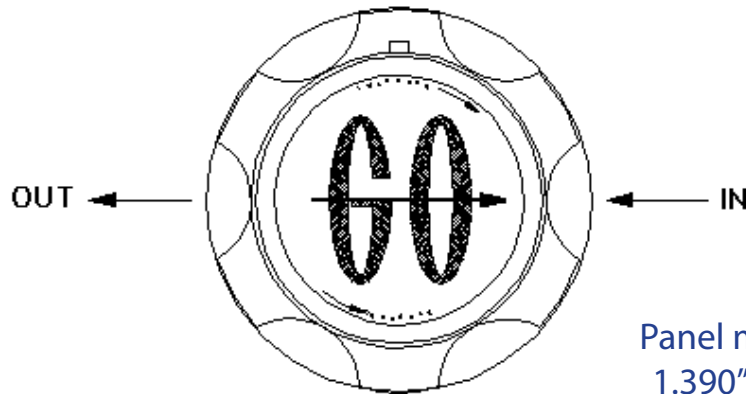

Panel mount option requires  
1.390" (35.3 mm) minimum  
diameter panel cut out

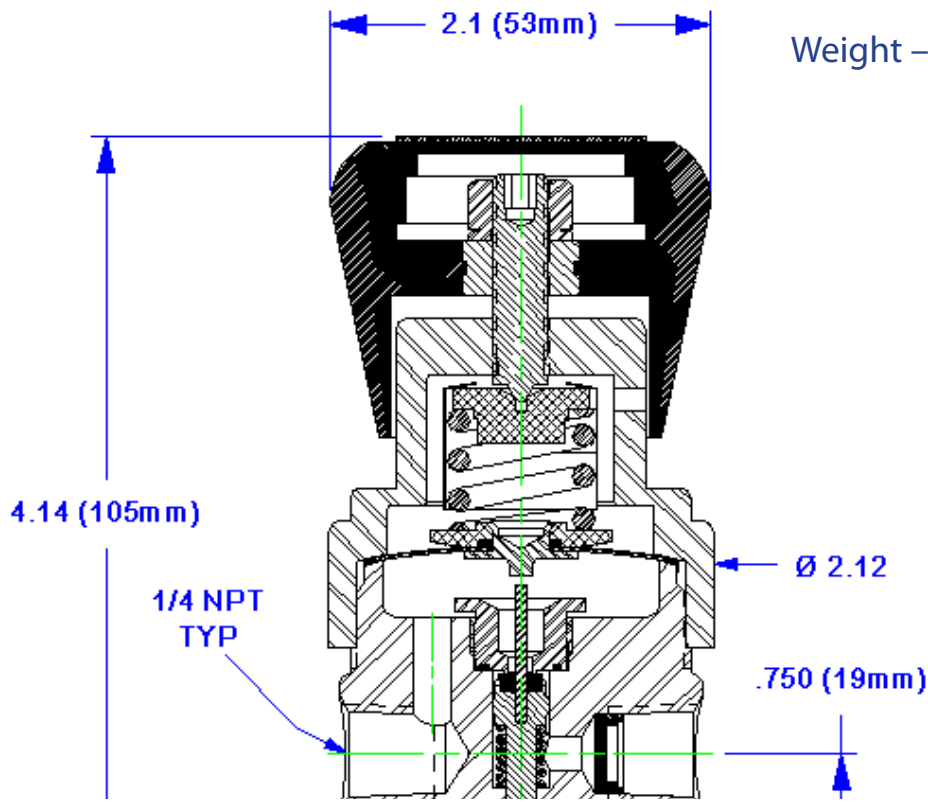

Weight – 1.9 lbs (0.86 kg)

## GO Regulator

405 Centura Court • PO Box 4866 • Spartanburg, SC 29303  
Phone (864) 574-7966 • Fax (864) 574-5608  
[www.goreg.com](http://www.goreg.com) • [sales@goreg.com](mailto:sales@goreg.com)