

PR-7 Series Pressure Regulator Adjusting Knob Installation Instructions

**Make sure you thoroughly understand these directions before proceeding
MAKE SURE THE REGULATOR IS DISCONNECTED FROM AIR SOURCE
MAKE SURE ANY RESIDUAL PRESSURE IS BLEED OFF FROM REGULATOR.**

Instructions

1. Completely read these instructions before performing any of the operations.
2. Make sure the regulator is disconnected from pressure source; make sure any residual pressure is bled off from the regulator. **FAILURE TO DO THIS WILL RESULT IN SERIOUS PERSONAL INJURY. DO NOT PROCEED UNTIL PRESSURE HAS BEEN REMOVED AND/OR TERMINATED**
3. Make sure the adjusting screw is unscrewed as far as possible (counter clockwise as viewed from the top of the regulator).
4. Engage the threads of the threaded insert in the knob onto the adjusting screw.
5. Spin down the knob until there is at least .30 (7.6mm) of the adjusting screw protruding from the knob insert. If necessary, use a 5/32 hexagonal wrench to prevent the adjusting screw from turning while spinning down the knob.
6. Engage the threads of the knob nut onto the end of the adjusting screw, making sure the locking teeth are facing the knob insert.
7. Spin down the knob nut until it makes contact with the knob/knob insert. If necessary, use a 5/32 hexagonal wrench to prevent the adjusting screw from turning while spinning down the knob nut.
8. Hold the knob securely. It may be necessary to use some sort of tool to facilitate this.
9. Using a 1/2 socket, tighten the knob nut to at least 10 lbf.ft. Make sure the knob **DOES NOT TURN** while you tighten the knob nut. If the knob nut is not sufficiently tight, the knob will spin on the adjusting screw while the regulator is in use. This is especially true for the higher outputs.
10. Install pry out plug.
11. The regulator is now ready for service.

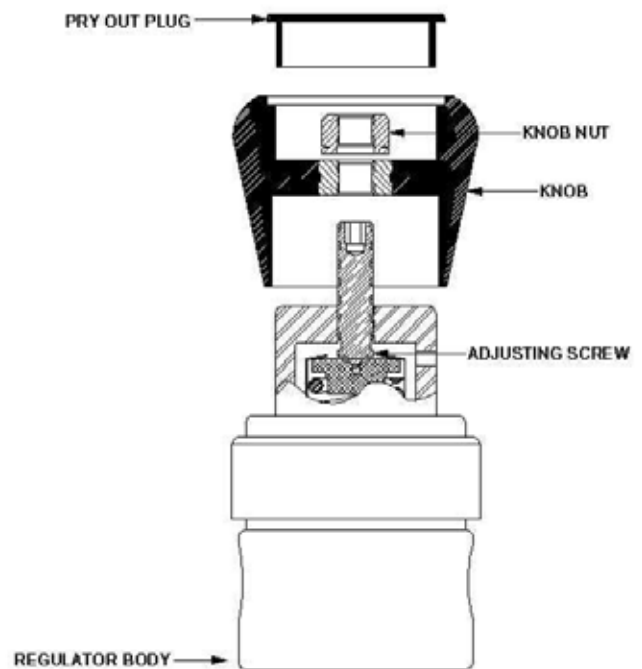

GO Regulator

405 Centura Court • PO Box 4866 • Spartanburg, SC 29303

Phone (864) 574-7966 • Fax (864) 574-5608

www.goreg.com • sales@goreg.com